



Installation instructions for PZ4AL- 00771- 00

## LEXUS GS 300, GS450H

Under Run Protective Shield engine bay



Model Year:	<b>GS 300 - 2005</b>	<b>GS450H - 2005</b>
Vehicle Code:	GRS190L-BETQHW	GWS191L-BEXQHW
Part Number:	PZ4AL- 00771- 00	PZ4AL- 00771- 00
 Weight:	13,3 kg	13,3 kg
 Installation Time:	30 min	30 min
Manual reference number:	AIM 002 049-0	AIM 002 049-0

**A**

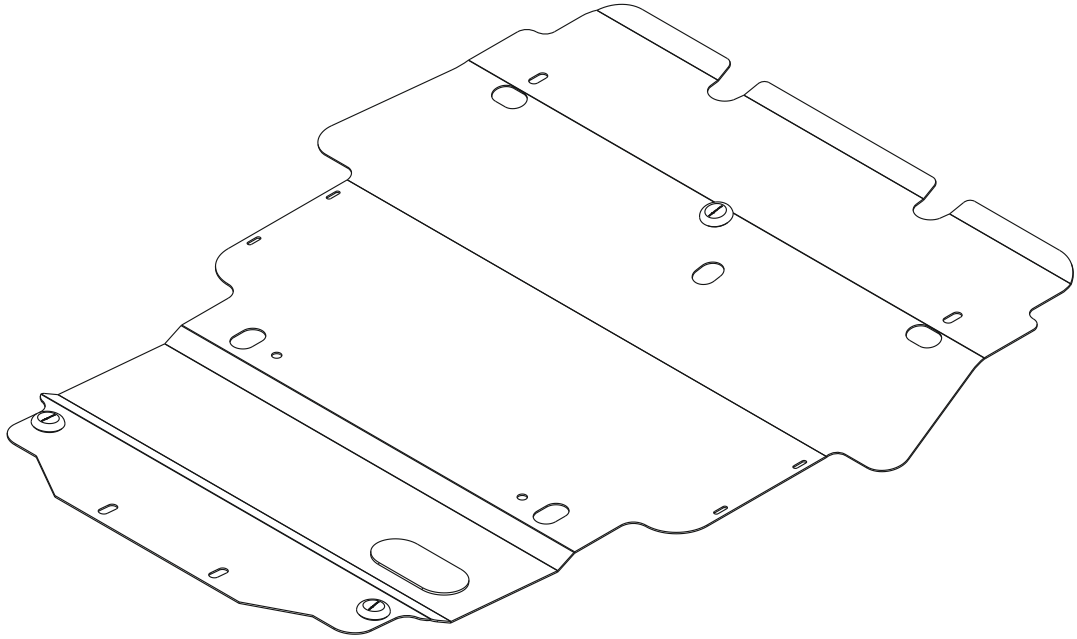

PZ4AL - 00771 - 60

**B**

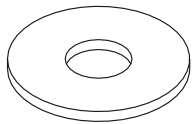

4 x Ø10

**C**

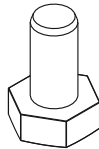

4x M10X30

**D**

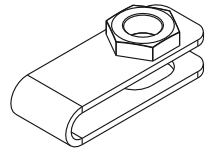

4 x

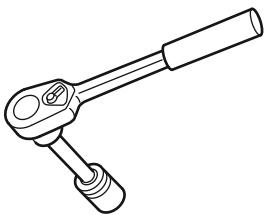

**1**

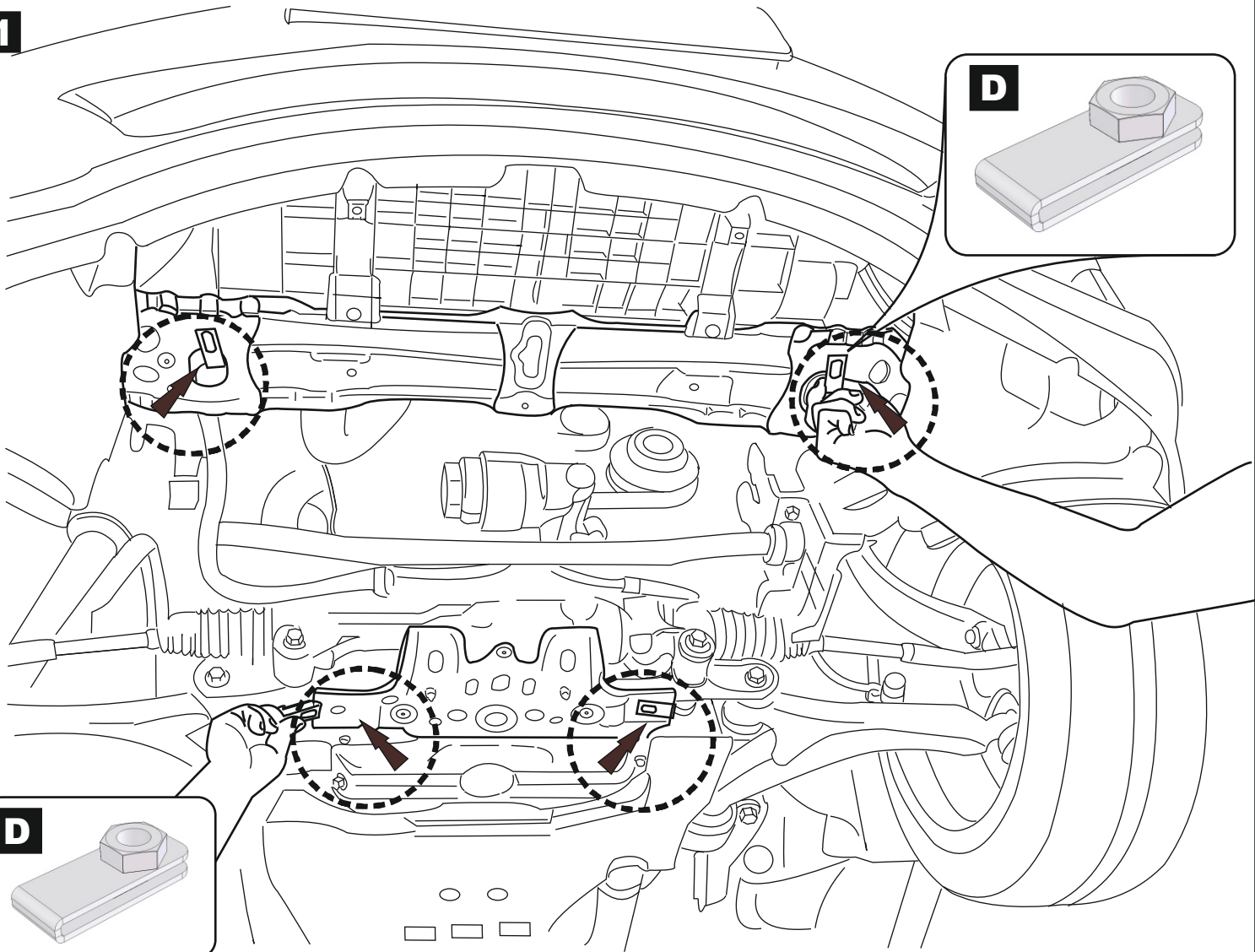
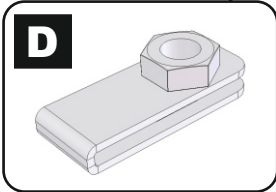
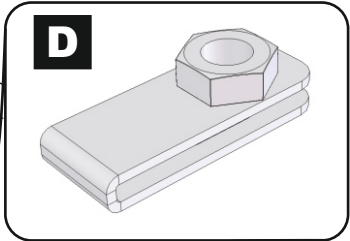

**2**

